

# Indian Journal of Pure & Applied Physics

<http://www.niscair.res.in>; <http://nopr.niscair.res.in>; Impact Factor: 0.739 (JCR 2015)

VOLUME 54

NUMBER 7

JULY 2016

CODEN : IJOPAU 54(7) 415-480

ISSN : 0019-5596 (print); 0975-1041 (Online)

## CONTENTS

### *Papers*

- |   |     |
|---|-----|
| A systematic performance evaluation of indigenously developed Shack-Hartmann wavefront sensor<br>Vikash Porwal, Awakash Dixit, Aditya Kumar Mangain, Sanjay Kumar Mishra & Arun Kumar Gupta | 419 |
| <i>Ab initio</i> calculation of electron transport in armchair graphane nano structure containing graphane quantum dot<br>Naveen Kumar, Jyoti Dhar Sharma & P K Ahluwalia                   | 427 |
| Hydrostatic pressure and polaronic effects on the confined energies in a spherical quantum dot<br>A Rejo Jeice & K S Joseph Wilson  | 431 |
| Enhancement in mechanical properties of silica low- <i>k</i> thin films using wet chemical technique<br>Yogesh S Mhaisagar, Anil S Gaikwad, Anil G Khairnar & Ashok M Mahajan               | 439 |
| An investigation on gamma and neutron shielding efficiency of lead-free compounds and alloys<br>Vishwanath P Singh & N M Badiger  | 443 |
| Empirical relationships between thermoelastic parameters<br>P K Vidyarthi & P K Singh   | 449 |
| Spectroscopic, thermal and dielectric studies on copper maleate monohydrate single crystals<br>M P Binitha & P P Pradyumnan   | 453 |
| Studies on optical properties of LiCaBO <sub>3</sub> : Tb <sup>3+</sup> phosphor<br>N S Bajaj & S K Omanwar   | 458 |
| Volumetric, viscometric and spectroscopic investigations of binary mixtures of o-chlorophenol with ethers<br>R N Shelar, A V Patil, C G Dighavkar & R Y Borse                               | 463 |
| Determination of available volume using thermo acoustical parameters and evaluation of ion-solvent interactions in liquid solutions<br>Brajabandhu Nanda                                    | 471 |





VISMAY KAMATE  
GUTKHA

96

MRINAL RAJARAM  
ENGLISH

101

ROHIT SHARMA  
THE ART OF REWRITING  
INDIAN EPICS

MALAYALAM

147

BOOKS

PLAY

RAMESH P. PANIGRAHI  
THE EMPEROR WITH HIS POT

107

RITA MALHOTRA  
THIS SUMMER AND THAT SUMMER  
BY SANJEEV SETHI

159



BROKEN MOON  
BY INDU K. MALLAH

161

ALL THE ANSWER I SHALL  
EVER GET  
BY TANYA MENDONSA

164

NITU  
INTO THE OBLIVION  
BY A.P. MAHESHWARI &  
VINEETA CHANDAK

167

CONTRIBUTORS

170



# INTERNATIONAL JOURNAL OF SCIENCE EDUCATION

Volume 38 Numbers 7-8 May 2016

## CONTENTS

### ISSUE 7

#### Articles

- 1057 Individual to collaborative: guided group work and the role of teachers in junior secondary science classrooms  
*Dennis Fung and Wai-mei Lui*
- 1077 Elementary teachers' use of content knowledge to evaluate students' thinking in the life sciences  
*Jaime L. Sabel, Cory T. Forbes and Leslie Flynn*
- 1100 Intersection of argumentation and the use of multiple representations in the context of socioscientific issues  
*Bahadir Namdar and Ji Shen*
- 1133 'They might know a lot of things that I don't know': investigating differences in preservice teachers' ideas about contextualizing science instruction in multilingual classrooms  
*Sara Tolbert and Corey Knox*
- 1150 Enhancing literacy practices in science classrooms through a professional development program for Canadian minority-language teachers  
*Léonard P. Rivard and Ndeye R. Gueye*
- 1174 College students' attitudes towards sexually themed science content: a socioscientific issues approach to resolution  
*Jamil Mikhail Yahaya, Ahmad Nurulazam and Mageswary Karpudewan*
- 1197 Comparison of three instructional strategies in food and nutrition education: developing a diet plan for a diabetic case  
*Aubteen Darabi, Shirin Pourafshar, Rinki Suryavanshi and Thomas 'Logan' Arrington*
- 1212 Enhancing student teachers' epistemological beliefs about models and conceptual understanding through a model-based inquiry process  
*Ioannis Soulios and Dimitris Psillos*

### ISSUE 8

- 1235 Science curiosity in learning environments: developing an attitudinal scale for research in schools, homes, museums, and the community  
*Jennifer L. Weible and Heather Toomey Zimmerman*
- 1256 Students' intentions towards studying science at upper-secondary school: the differential effects of under-confidence and over-confidence  
*Richard Sheldrake*
- 1278 The role of outside-school factors in science education: a two-stage theoretical model linking Bourdieu and Sen, with a case study  
*Tuba Gokpinar and Michael Reiss*
- 1304 Context-based assessment: creating opportunities for resonance between classroom fields and societal fields  
*Alberto Bellocchi, Donna T. King and Stephen M. Ritchie*
- 1343 Developing and evaluating a paper-and-pencil test to assess components of physics teachers' pedagogical content knowledge  
*Sophie Kirschner, Andreas Borowski, Hans E. Fischer, Julie Gess-Newsome and Claudia von Aufschnaiter*
- 1373 Learning nanotechnology with texts and comics: the impacts on students of different achievement levels  
*Shu-Fen Lin and Huann-shyang Lin*
- 1392 Students' evaluations about climate change  
*Doug Lombardi, Carol B. Brandt, Elliot S. Bickel and Colin Burg*

୬୮ତମ ବର୍ଷ : ୪ର୍ଥ ସଂଖ୍ୟା ■ କର୍କଟ: ୧୪୨୩ ସାଲ ■ ଜୁଲାଇ-୨୦୧୬

ପ୍ରବନ୍ଧ ଓ ସାହିତ୍ୟ-ସମାଲୋଚନା	
ଶ୍ରୀକଗନ୍ଧାର୍ଥ ସଂସ୍କୃତିର ଗବେଷଣା    ମହାମୋହନ ତ୍ରିପାଠୀ	୩୭୧
ବେଦୋତ୍ତର ସଂସ୍କୃତ ସାହିତ୍ୟରେ ପୁରୁଷୋତ୍ତମ ଜଗନ୍ନାଥ    ଅତ୍ୟୟାମୀ ମିଶ୍ର	୩୭୫
ଜନ୍ମଦିନର ମହୋତ୍ସବ: ମହାସ୍ନାନ ଯାତ୍ରା    ଶରତ ଚନ୍ଦ୍ର ପରିଡ଼ା	୩୮୦
ମହିମାଧର୍ମ ଓ ଦର୍ଶନରେ ଶ୍ରୀକଗନ୍ଧାର୍ଥ    ଦୀପ୍ତିରଞ୍ଜନ ମହାଲିକ	୩୮୯
ଯୋ ବୁଦ୍ଧବାନ୍ ସଦୈବ ଜ୍ଞାତାୟ ସ ବୁଦ୍ଧେ ଜଗଦ୍‌ାଶ୍ଵରଃ    କ୍ଷେତ୍ରବାସୀ ମାନସେଠ୍	୩୯୩
ନୂଆ ଜଙ୍ଗଲ କାହାଣୀ-ଅବ୍ୟକ୍ତ ଅଭୀପ୍ସା    ନରବର ଶତପଥୀ	୩୯୭
କବିତା	
କ'ଣ କରିବାର ଅଛି    ବଂଶୀଧର ଷଡ଼ଙ୍ଗୀ	୪୦୩
କବିତାର ଶରଣଯ୍ୟା    ସରୋଜିନୀ ଷଡ଼ଙ୍ଗୀ	୪୦୪
ଧାନ ବିଷୟରେ ଅଧ୍ୟାଲେଖା କବିତା ପାଇଁ କେତୋଟି ଷ୍ଟେର୍    ଶତ୍ରୁଘ୍ନ ପାଣ୍ଡବ	୪୦୫
ଭାଷା ଆନ୍ଦୋଳନ    ସୁରେତା ମିଶ୍ର	୪୦୭
ଅବ୍ୟର୍ଥ ଉପଯୋଗ    ସରୋଜିନୀ ମିଶ୍ର	୪୦୮
ଶରଧାବାଲିରୁ ମୁଁ ଠାଏ ମାଗିଲି...    ଅପର୍ଣ୍ଣା ମହାନ୍ତି	୪୦୯
ଭିକା ମାଟି    ଦୀପ୍ତି ଦାସ	୪୧୦
ଶ୍ରୀମାନ ଓଡ଼ିଶା    ହୁସେନ ରବିଗାଁଧୀ	୪୧୧
ଗୀତି	
କବିତାକୁ ଗୀତପଦେ    ସତ୍ୟ ପଟ୍ଟନାୟକ	୪୧୩
ଗୋଧୂଳିଗାଁର ଗୀତ    ଧନଞ୍ଜୟ ସ୍ଵାଇଁ	୪୧୪
ଗଞ୍ଜ	
ଜଣେ ପ୍ରତୁତଭୁବିଦ୍ଙ୍କ ଜୀବନରେ ଗୋଟିଏ ଦିନ    ଦୀପ୍ତିରଞ୍ଜନ ପଟ୍ଟନାୟକ	୪୧୫
ଗଣେଶପ୍ରତିମା    ସହଦେବ ସାହୁ	୪୨୩
ବିପନ୍ନ ବିଶ୍ଵକର୍ମା    ଘନବିହାରୀ ମହାରଣା	୪୨୮
ଦାଗ    ମମତାମୟୀ ଚୌଧୁରୀ	୪୩୫
ନିରାଶାର ସମାପରେ    ମାନାକ୍ଷି ପାଢ଼ି	୪୪୩
ଏକାଙ୍କିକା	
ଉପସିତ ମୁହୂର୍ତ୍ତର ଅପେକ୍ଷାରେ    ସଂଘମିତ୍ରା ମିଶ୍ର	୪୪୯
ଧାରାବାହିକ ଉପନ୍ୟାସିକା	
ଲ୍ୟାଣ୍ଡମାଇନ୍    ଶଶି ରଥ	୪୬୧
ପ୍ରତିବେଶୀ ସାହିତ୍ୟ	
କଥାକୁହା ଲଙ୍ଗଳ    ମାଲାୟଲମ: ପଙ୍କଜମ୍ବୁ ବାକୀ	
ଅନୁବାଦ: ରବୀନ୍ଦ୍ର କୁମାର ପ୍ରହରାଜ	୪୭୧
ସଂପାଦକୀୟ	
ଇତିହାସ ଚର୍ଚ୍ଚାର ପରମ୍ପରା    ସରୋଜରଞ୍ଜନ ମହାନ୍ତି	୪୭୭
ଲେଖକ ପରିଚିତି	୪୭୯



ପ୍ରବ  
ମୁଖ୍ୟତଃ  
ପୁରାଣ ପୁ  
ବିରୋଧୀ  
ଭିତ୍ତିକ  
ଏକଦେଶ  
ଚିନ୍ତାଧାର  
କିମ୍ବଦନ୍ତୀ  
ଉଚିତ ନୁ  
କରାଯିବା  
ଭ୍ରମାତ୍ମକ  
ଆଲୋଚକ  
ଶ୍ରୀକଗନ୍ଧାର୍ଥ  
ପଂ  
ଗୋଟିଏ ପ୍ର  
କି ନାହିଁ  
ଭୂମି (୧) ।  
ଆରମ୍ଭରୁ ଜ  
ବିନା ତାଙ୍କ  
ଏନ.ଏସ.  
ପ୍ରାଚୀନତମ  
ସଂସ୍କୃତିର ମୁ  
'ଗଣ୍ଡ଼ୋଳା  
ଯାଏଁ ଦାକ୍ଷିଣ  
ପାର୍ବତ୍ୟାଞ୍ଚଳ  
ସିଦ୍ଧାନ୍ତ ପ  
ଶୁଭଗାମିନୀ  
ମଧ୍ୟ ବର୍ଷତ ୧  
୬୮ତମ ବର୍ଷ

CONTENTS

Regular Articles

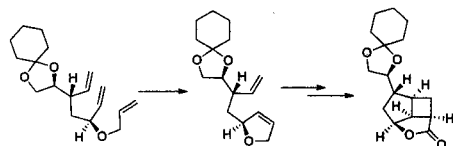

**A simple approach to the construction of the core structure present in bielschowskysin and hippolachnin A**

Ritabrata Datta, Malasala Sumalatha and Subrata Ghosh. . . . . 1019–1023

Synthesis of oxacyclobutapentalene, the core structure of bielschowskysin and hippolachnin A, has been achieved through ring closing metathesis and Cu(I)-catalysed intramolecular [2+2] photocycloaddition as the key steps.

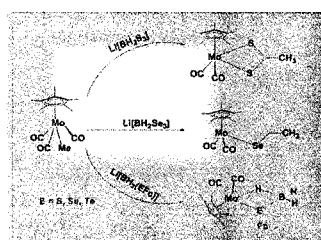

**Reactivity of [Cp\*Mo(CO)<sub>3</sub>Me] with chalcogenated borohydrides Li[BH<sub>2</sub>E<sub>3</sub>] and Li[BH<sub>3</sub>EFc] (Cp\* = (η<sup>5</sup>-C<sub>5</sub>Me<sub>5</sub>); E = S, Se or Te; Fc = (C<sub>5</sub>H<sub>5</sub>-Fe-C<sub>5</sub>H<sub>4</sub>))**

Rongala Ramalakshmi, Koushik Saha, Anamika Paul and Sundargopal Ghosh . . . . . 1025–1032

Reactivity of [Cp\*Mo(CO)<sub>3</sub>Me] with various chalcogenide ligands such as, Li[BH<sub>2</sub>E<sub>3</sub>] and Li[BH<sub>3</sub>EFc] (E = S, Se or Te; Fc = (C<sub>5</sub>H<sub>5</sub>-Fe-C<sub>5</sub>H<sub>4</sub>)), generated novel molybdenum thiolate and agostic borate complexes respectively.

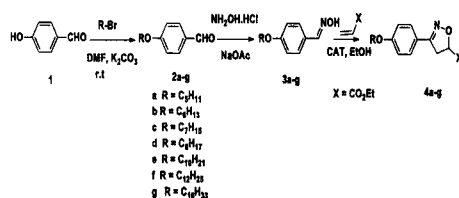

**Synthesis of new series of 4, 5-dihydroisoxazole-5-carboxylate derivatives for the study of their liquid crystalline properties**

Sumana Y Kotian, Narayana U Kudva N, K M Lokanatha Rai and K Byrappa. . . . . 1033–1036

Synthesis and characterization of a few isoxazoline derivatives and their liquid crystalline properties are described.

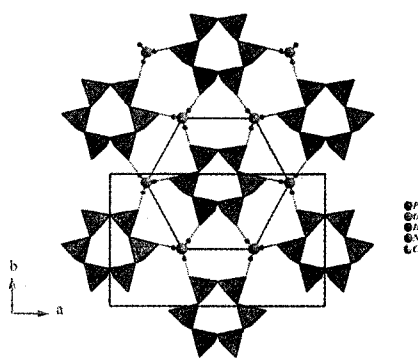

**Synthesis and Characterization of a new Cyclohexaphosphate, (C<sub>9</sub>H<sub>14</sub>N)<sub>4</sub>(H<sub>3</sub>O)<sub>2</sub>(P<sub>6</sub>O<sub>18</sub>)**

L Khedhiri, E Jeanneau, F Lefebvre, M Rzaigui and C Ben Nasr . . . . . 1037–1045

Structure and physicochemical properties of a new cyclohexaphosphate, (C<sub>9</sub>H<sub>14</sub>N)<sub>4</sub>(H<sub>3</sub>O)<sub>2</sub>(P<sub>6</sub>O<sub>18</sub>), are discussed on the basis IR spectrum, solid state MAS-NMR and X-ray crystal structure. The cyclohexaphosphate anion, with chair conformation, is generated by crystallographic inversion symmetry. The atomic arrangement can be described by thick layers built by P<sub>6</sub>O<sub>18</sub> anions and H<sub>3</sub>O<sup>+</sup> cations parallel to the (a, b) plane. Each cyclohexaphosphate group is connected to its adjacent neighbors by six hydronium ions through strong O-H...O hydrogen bonds.



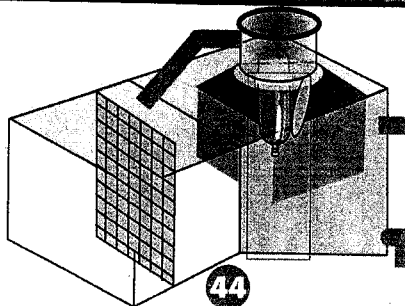

**TECHNOLOGY**

**Too soon to celebrate**

Bio-toilets are gaining ground. But emerging challenges could defeat their very purpose

44

41

**SCIENCE**

**Tilting the balance**

The use of artificial light during night has led to early onset of spring in the UK

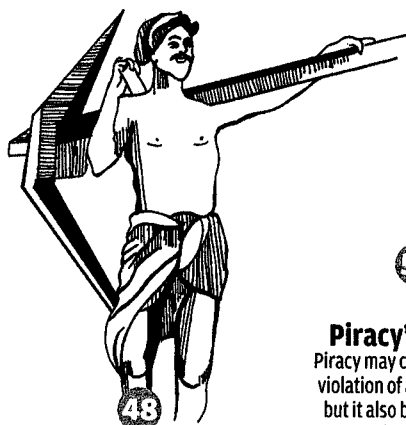
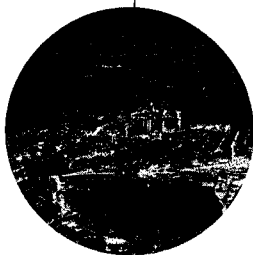

48

**FACTSHEET**

**On the edge**

Climate change will hit farmers in more than half of the country by 2050

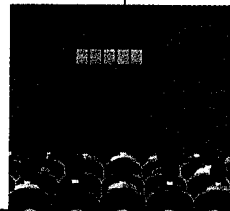

54

**Piracy's upside**

Piracy may cause copyright violation of artistes' work, but it also brings in fame and popularity

58

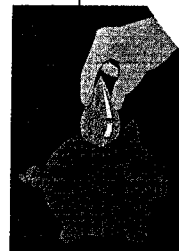

**Adversity is the best teacher**

Residents of drought-scarred Bundelkhand know how to manage their region

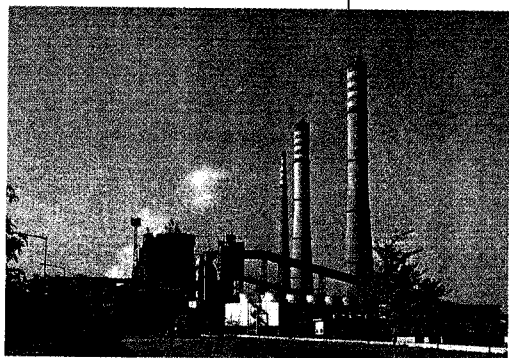

**ANALYSIS**

**Time to bid adieu**

Around 20 per cent of India's coal-based power plants have completed their life. It is time to shut them down

38

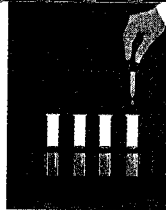

**Gender (in)sensitive**  
Modern medicine and clinical trials have been male-centric. The trend is now changing

46

**DEBATE**

**Gauging GDP's efficacy**

A new book tries to evaluate whether Gross Domestic Product is a true and accurate measure of growth and prosperity

50



**OPINION**

**Ambiguous perks of GI tag**

Will Protected Geographical Indication for Darjeeling tea act as safety-net for small growers in times of crisis?

56



42



**HEALTH**

**Return of the black fever**

Treating kala-azar, or visceral leishmaniasis, is becoming difficult due to new complications

### Review of Rural Affairs

In this issue of the Review of Rural Affairs the focus is on village studies. Five papers present the results of restudies of villages, three of which were first studied by British anthropologists in the 1950s. One paper discusses the theoretical and methodological challenges of undertaking such village restudies while two others study villages in Uttar Pradesh. The results of an evaluation of rural Nagaland are presented in yet another paper.

### Revisiting the Rural in 21st Century India

- 5 This introductory essay presents the context in which village studies emerged as a method of understanding rural society and economy in India, and the significance of going back to the village to try and understand the changing dynamics of caste, class and gender in 21st century India. — *Surinder S Jodhka*

### Land, Labour and Power: A Malwa Village, 1954–2012

- 8 Jamgod in Dewas district of Madhya Pradesh was first studied by Adrian C Mayer in the 1950s, and restudied in the period between 2012 and 2014. The results suggest that even as there have been significant changes in the economic landscape of the village, factors like land, labour and power continue to determine the nature of the village in rural India, and its connections with the wider world. — *Tommaso Sbriccoli*

### Migration, Bachelorhood and Discontent among the Patidars

- 17 Restudying Sundarana in Central Gujarat, which was first studied by David Pocock in the 1950s, this paper revisits the relatively prosperous agricultural Patidar community. Its members are coming to terms with new markers of status which are linked to securing employment away from land, possibly to move away from the village and preferably secure a job overseas. — *Alice Tilche*

### F G Bailey's Bisipara Revisited

- 25 This restudy of a village first studied by F G Bailey in the 1950s tries to understand the issue of temple entry in Bisipara. The unsuccessful attempts to enter the Shiva temple described by Bailey are compared to more recent events surrounding it, and are discussed as a manifestation of contested postcolonial identity politics. — *Tina Otten, Edward Simpson*

### Village Studies: Trials and Tribulations

- 33 Describing the conception of the project to restudy three villages, first studied by British anthropologists in the 1950s, this paper discusses the value of good record-keeping, the importance of reflexivity, the theoretical and methodological challenges of taking up such studies, and also the charm of working with two of the original researchers. — *Edward Simpson*

### Non-farm Diversification, Inequality and Mobility in Palanpur

- 43 Over the past seven decades social scientists have studied Palanpur in Uttar Pradesh several times. This paper documents the changes in intergenerational mobility, the nature of the shift in employment to non-farm occupations especially in poorer households, and the importance of networks and family ties in finding better, more remunerative employment. — *Himanshu, Bhavna Joshi & Peter Lanjouw*

### Inequality in Rural Nagaland: Changing Structures and Mechanisms

- 52 Challenging the usual perception that tribal villages are more egalitarian compared to the caste-structured villages of India, this paper argues that class and status are determined more by the ability to move away from the village than by clan rank or the organisation of agriculture alone, which are otherwise considered significant determinants of mobility. — *Andreas Küchle*

### Agrarian Transformation and the New Rurality in West Uttar Pradesh

- 61 Khanpur in Uttar Pradesh was first studied by the author in 2004–05 and once again a decade later. The results of the study suggest that with the rise in non-farm employment opportunities, changing demographics, more educational opportunities, and increased mobility of castes and communities, there have been changes in the nature and culture of rural life in the region. — *Satendra Kumar*

Economic and Political Weekly SUPPLEMENT

Printed by K Vijayakumar at Modern Arts and Industries, 151, A-Z Industrial Estate, Ganpatrao Kadam Marg, Lower Parel, Mumbai-400 013 and published by him on behalf of Sameeksha Trust from 320-321, A-Z Industrial Estate, Ganpatrao Kadam Marg, Lower Parel, Mumbai-400 013.

Editor: Paranjoy Guha Thakurta.



## Economic & Political WEEKLY

### EDITORIALS

Foreign Policy Fizzles Out.....	7
Battle Far From Won.....	8
Networks of Morbidity.....	9

### 50 YEARS OF EPW.....9

### STRATEGIC AFFAIRS

Skidding Down the Strategic Slope: Indo-US Relations— <i>Srinath Raghavan</i> .....	10
---	----

### COMMENTARY

Adivasis in Conflict Zone: Bastar 2016— <i>Archana Prasad</i> .....	12
The 'Spittoon Syndrome' — <i>Chitra Grace, Kesavan Rajasekharan Nayar, Lekha D Bhat, Anant Kumar, G Ratheesh Babu, Muhammed Shaffi</i> .....	15
Baluta and Joothan amid Humiliation— <i>Purnachandra Naik</i> .....	19
Clean India, Unclean Indians Beyond the Bhim Yatra— <i>Paul D'souza</i> .....	22
How Not to Fight Discrimination in India— <i>R K Debbarma</i> .....	25
The Trophy Hunting Debate: A Case for Ethics— <i>Aejaz Ahmad</i> .....	29
A Feminist Way of Life: Trupti Shah (1962–2016)— <i>Vibhuti Patel</i> .....	32

### BOOK REVIEWS

The Left beyond Marxism— <i>Pratyush Chandra</i> .....	35
Politics of the Womb— <i>Asha Achuthan</i> .....	39
Enabling Financial Inclusion— <i>S Mahendra Dev</i> .....	42

### PERSPECTIVES

Ambivalence of Citizenship in Assam— <i>Anupama Roy</i> .....	45
---	----

### MIGRANTS AND THE CITY

Migrant and the Neo-liberal City: An Introduction— <i>Ranabir Samaddar</i> .....	52
Recycling the Urban: Contemporary Kolkata— <i>Iman Kumar Mitra</i> .....	55
Street Dwelling and City Space: Women Waste Pickers in Kolkata— <i>Debarati Bagchi</i> .....	63
Homeless Migrants in Mumbai: Life and Labour in Urban Space— <i>Manish K Jha, Pushpendra Kumar</i> .....	69
Sleepless in Mumbai: Spotlight on Elderly Security Guards— <i>Mouleshri Vyas</i> .....	78

### SPECIAL ARTICLES

Sustainable Development as Environmental Justice— <i>Nupur Chowdhury</i> .....	84
Social History of Jamma Land Tenure in Kodagu— <i>M A Kalam</i> .....	93
Changing Economic Formation of Himachal Pradesh— <i>Yogesh Snehi</i> .....	101

### NOTES

Data for Research into Health Inequality in India: Do We Have Enough?— <i>Nandita Saikia, P M Kulkarni</i> .....	111
--	-----

### ECONOMIC NOTES

Estimates of High GDP Growth for 2015–16: Not Entirely Convincing— <i>J Dennis Rajakumar</i> .....	117
--	-----

### POSTSCRIPT

The Ignoble Comparison— <i>Arvind Krishnaswamy</i> (121), From Polls to Trolls— <i>C S Venkiteswaran</i> (122), Four Rubaiyat— <i>Nabina Das</i> (124)	
--	--

### LETTERS.....4

## Economic & Political WEEKLY

### EDITORIALS

Should India Be a Member of the Sheriff's Posse?.....	7
'Divine-bodied' Disabled.....	8

### COMMENT

Bangladesh: Whose 'Unfinished Revolution'?.....	8
---	---

### 50 YEARS OF EPW.....9

### MARGIN SPEAK

Rohith Vemula's 'Dalitness' — <i>Anand Teltumbde</i> .....	10
---	----

### COMMENTARY

The Gujarat Vote Share Trend Conundrum— <i>Darshan Desai</i> .....	12
e-Platform for National Agricultural Market— <i>Ramesh Chand</i> .....	15
Not in People's Interest— <i>Sugata Marjit</i> .....	18
From Great Britain to Little England, via Brexit— <i>Radha D'Souza</i> .....	20
UK Spirals into Political Crisis after EU Vote— <i>Kirsty Hughes</i> .....	22

### BOOK REVIEWS

<i>Untranquil Recollections: The Years of Fulfilment—Birth of Bangladesh: Recollections of a Politician Economist</i> — <i>Habibul Haque Khondker</i> .....	24
<i>Other People's Money: The Real Business of Finance—Reforming the Risky Financial System</i> — <i>Thomas E Weisskopf</i> .....	27

### INSIGHT

Science and the Scientist in a Changing Climate— <i>Radha Gopalan</i> .....	30
---	----

### SPECIAL ARTICLES

Measurement of Regulations of the Agricultural Produce Markets: An Application to Indian States— <i>Purnima Purohit</i> .....	36
Rethinking Economics, Statistical System and Welfare: A Critique with India as a Case— <i>R B Barman</i> .....	46

### DISCUSSION

Trade Unions in Banks Remain Relevant: A Rejoinder— <i>T R Bhat</i> .....	57
---	----

### CURRENT STATISTICS..... 61

### APPOINTMENTS/PROGRAMMES/ ANNOUNCEMENTS.....63

### LETTERS.....4

## Economic & Political WEEKLY

### EDITORIALS

- 'Mockery' of Democratic Process .....7
- Washington's 'Major Defence Partner' ..... 8
- J&K's Agonising Wait for a Democratic Solution ... 8

### 50 YEARS OF EPW .....9

### HT PAREKH FINANCE COLUMN

- Is Brexit Moment a Lehman Moment? Fear Factor in Financial Crises—*T Sabri Öncü* ..... 10

### COMMENTARY

- Concentration, Collusion and Corruption in India's Banks: Roots of the Bad Debt Crisis—*Sumit K Majumdar* .....12
- Safeguarding Educational Rights of Minorities—*Saima Saeed* .....15
- What Is at Stake in Rewriting California School Textbooks?—*Chinnaiah Jangam* .....18
- Ethnic Tension in Mizoram: Contested Claims, Conflicting Positions—*Roluahpuia* .....21

### BOOK REVIEWS

- Gujarat Files: Anatomy of a Cover Up*—Compelling Anatomy of Communalism and Power—*Harsh Mander* ..... 26
- Inside China's Automobile Factories: The Politics of Labour and Worker Resistance*—*Lean and Mean China*—*Annavajhula J C B* ..... 29

### PERSPECTIVES

- A Hard Look at National Security—*Gautam Navlakha* ..... 32

### 25 YEARS OF ECONOMIC LIBERALISATION

- Looking Back and Looking Ahead at the Liberalisation Process ..... 38
- The 1991 Reforms: How Home-grown Were They?—*Montek S Ahluwalia* ..... 39
- Economic Liberalisation and the Working Poor—*Prabhat Patnaik* ..... 47
- Making Reforms Work for the Common People—*Rajiv Kumar* .....51
- Politics of Growth: Script and Postscript—*Atul Sood* ..... 56
- Indian Economy in Transition: The New Order of Things—*Anjan Chakrabarti* .....61
- TINA, India and Economic Liberalisation—*T Sabri Öncü* ..... 67
- No Room for Complacency: Can We Afford Build-up of External Liabilities?—*A V Rajwade* ..... 72
- A-Meri-India: A Note from the Land of Frustrated Aspirants—*Aseem Shrivastava* ..... 75

### DISCUSSION

- Teaching-Learning Process—*Sayantan Mandal* ..... 79

### CURRENT STATISTICS ..... 160

### POSTSCRIPT

- A Muslim Feminist Looks at Sex—*Wajiha Mehdi* (163), Their God Died Young—*Nirupam Hazra* (164), Shakespeare Lives!—*N S Gundur* (165), My Khasi Home—*P S Leela* (166), Last Lines (166)

### APPOINTMENTS/PROGRAMMES/

### ANNOUNCEMENTS .....169

### LETTERS .....4

## Economic & Political WEEKLY

### EDITORIALS

- Governor 'Adventurism' .....7
- Regulating Service-oriented Professions ..... 8

### COMMENT

- Shooting the Messenger ..... 9

### 50 YEARS OF EPW .....9

### LAW & SOCIETY

- Securing Women's Right to Free Speech on Social Media—*Alok Prasanna Kumar* ..... 10

### COMMENTARY

- Manipur and Mainstream Media: Lost in the Rhetoric—*Pradip Phanjoubam* .....12
- Opaqueness of Environmental Information in India—*Shivananda Shetty, Surender Kumar* ..... 15
- Reviewing India's National Mission on Electric Vehicles—*Ganeshprasad Pavaşkar* .....19
- Is the Government Justified in Reducing R&D Tax Incentives?—*Sunil Mani, Janak Nabar* ..... 22
- Remembering Xulhaz—*Kasia Paprocki* ..... 26

### BOOK REVIEWS

- Rentier Capitalism: Disorganised Development and Social Injustice in Pakistan*—Understanding What Has Gone Wrong in Pakistan—*Hiren Sarkar* ..... 29
- Bullets and Bylines: From the Frontlines of Kabul, Delhi, Damascus and Beyond*—A Newsman's Saga—*Arvind Krishnaswamy* ..... 31

### PERSPECTIVES

- GSPC: A Controversial Case Study—Attempts Are Being Made to Bail Out a Gujarat Government Company—*Paranjy Guha Thakurta* .....33

### SPECIAL ARTICLES

- Regional Divide in Banking Development in Maharashtra—*Pallavi Chavan* ..... 46
- Contextualising Transnationalism: Local Embedment and Global Engagement amongst Gujarati Indians in Cape Town—*Molly Fitzpatrick, Mario Rutten* .....57
- Of Gandhi, Godse and the Missing Files: *Nine Hours to Rama* (1963)—*Ravinder Singh* .....65

### NOTES

- Political Economy of US-Pakistan Relations: Reformulating the Patron-Client Model—*Danish Khan* .....73

### CURRENT STATISTICS ..... 78

### APPOINTMENTS/PROGRAMMES/

### ANNOUNCEMENTS ..... 81

### LETTERS .....4

*Publisher***Suresh Chandra Sharma***Editor***G S Reddy***Asst. Editor***Payal Sharma***Consultant Editor***K S Sarma, IAS (Retd.)**

Former Chairman, ICSSR

Former CEO, Prasar Bharati.

*Editorial Board***Sri C Ramaiah**

IIT Coaching Centre, Hyderabad

**Prof. Ghanta Ramesh**

Senior Professor of Education, Maulana Azad National Urdu University, Hyd.

**Prof. H S Srivastava**

Chevalier dans l'Ordre des Palmes Academiques Former Dean (Academic), NCERT, New Delhi.

**Prof. C L Kundu**

Advisor, Rehabilitation Council of India, New Delhi.

**Dr. L Govinda Rao**

Former Director, National Institute for the Mentally Handicapped, Secunderabad.

**Prof. Marlow Ediger**

Professor Emeritus of Education, Truman State University, USA.

**Dr. S K Mangal**

Eminent Educationist, Rohtak.

**Prof. V Sudhakar**

Prof. of Education, Dept. of Education, EFLU, Hyderabad.

**Prof. D. Kumaran**

Professor &amp; Head, Dept. of Education, University of Madras, Chennai.

© Neelkamal Publications Pvt. Ltd.  
All rights reserved. Reproduction in any manner is prohibited.

*Printed & Published by***Suresh Chandra Sharma**

Managing Director,

**Neelkamal Publications Pvt. Ltd.,***on behalf of***Neelkamal Publications Pvt. Ltd.,**

Koti, Hyderabad - 500 095, India.

© : 91-40-24757140, 91-40-24757197,

Fax : 91-40-24757951.

website : www.neelkamalbooks.com

e-mail : neelkamalbooks@gmail.com

Delhi Office: 4764/1, 23, Ansari Road,

Daryaganj, New Delhi-110 002, India.

© : 91-11-23244237

The views expressed in the articles inside are the individual opinions of the authors and they in no way represent or reflect the opinion of EDUTRACKS nor does EDUTRACKS subscribe to these views in any way. All disputes are subject to the jurisdiction of Hyderabad courts only.

# Inside

**Articles****05 .. Can you Improve Your Memory by Sleight of Hand?***Dr. S. Dandapani***07 .. Gandhi's Vision on Changing Educational Perspectives Its Relevance in the 21<sup>st</sup> Century***Dr. S. Prabu Shankar***10 .. Parents as Sexual Health Educators***Gifty Joel, Dr. Venkat Lakshmi H.***Research****14 .. B Ed Students Attitude towards Environmental Education***Dr. R. Anandarasu***19 .. Awareness of Right to Information Act (2005) among B Ed Student-Teachers in Coimbatore District***K. Arunkumar, S. Kirithika***23 .. Impact of Frustration on Teaching Efficiency of Schoolteachers***Dr. Ishwar Singh Bargah***26 .. Relationship between Social Sensitivity and Professional Development of Higher Secondary Schoolteachers of Kerala***Muhammed Amanulla. A.K., Dr. P.K. Aruna***35 .. Comparative Study of the Teaching Aptitude of Fresh Categories of Student-Teachers with those of In-Service Categories in Relation to their Personality Variables***Rajesh Kumar Srivastav***42 .. Attitude of Elementary Schoolteachers towards CCE***Dr. G.C. Pradhan***47 .. Health Track****51 .. News Track**

# Harvard Educational Review

VOLUME 85      NUMBER 4      2015

## ARTICLES

- MICHELLE J. BELLINO 537 *The Risks We Are Willing to Take: Youth Civic Development in "Postwar" Guatemala*
- CATI COE 562 *Cultural Capital and Transnational Parenting: The Case of Ghanaian Migrants in the United States*  
SERAH SHANI
- LESLIE DUHAYLONGSOD 587 *Toward Disciplinary Literacy: Dilemmas and Challenges in Designing History Curriculum to Support Middle School Students*  
CATHERINE E. SNOW  
ROBERT L. SELMAN  
M. SUZANNE DONOVAN
- UMA M. JAYAKUMAR 609 *The Shaping of Postcollege Colorblind Orientation Among Whites: Residential Segregation and Campus Diversity Experiences*
- SHAUN R. HARPER 646 *Black Male College Achievers and Resistant Responses to Racist Stereotypes at Predominantly White Colleges and Universities*

## BOOK NOTES

- 675 *Learning to Improve: How America's Schools Can Get Better at Getting Better*  
by Anthony S. Bryk, Louis M. Gomez, Alicia Grunow, and Paul G. LaMahieu
- 679 *How Did You Get Here? Students with Disabilities and Their Journeys to Harvard*  
by Thomas Hehir and Laura A. Schifter
- 683 NOTES ON CONTRIBUTORS
- 686 GUIDELINES FOR AUTHORS
- 689 INDEX TO VOLUME 85

# Indian Journal of Experimental Biology

<http://www.niscair.res.in>; <http://nopr.niscair.res.in>

**VOLUME 54**

**NUMBER 7**

**JULY 2016**

CODEN: IJEB (A6) 54 (7) 421-488 (2016)

ISSN: 0019-5189 (Print); 0975-1009 (Online)

## CONTENTS

### Papers

- Assessment of *Arabidopsis thaliana* CENH3 promoter in *Brassica juncea* for development of haploid inducer lines 425  
Anshul Watts, Jyoti Bhadouria, Vajinder Kumar & Shripad Ramachandra Bhat\*
- Isolation and characterization of the Lepidoptera-specific *Bacillus thuringiensis* strains predominantly from the north eastern states of India 431  
M Tripathi, Arvind Kumar, Archana Kumari, Vinay Kalia, AK Saxena & Govind Gujar\*
- Differential antibrucella activity of bovine and murine macrophages 452  
Raheela Akhtar\*, Zafar Iqbal Chaudhary & Muhammad Younus
- Effect of flavonoid rich fraction of *Tephrosia purpurea* (Linn.) Pers. on complications associated with streptozotocin-induced type I diabetes mellitus 457  
Ramesh K Goyal\* & Shraddha Bhadada
- Note**
- Antioxidant activity of *Wattakaka volubilis* (Linn. f.) leaf extract in carbon tetrachloride induced mice 467  
Rajeswari Satapathy, Ram S Jadhav and Paramjyoti L. Swamy\*
- Validation of PCR based detection system for aflatoxin producing molds 472  
Manisha Mangal\*, Farha Khan, Sangita Bansal & HS Oberoi
- A rapid efficient protocol for in vitro multiplication of genetically uniform *Stevia rebaudiana* (Bertoni) 477  
Khan A, Jayanthi M\*, Nagavara Prasad Gantasala, Bhooshan N & Uma Rao
- Influence of light intensity, temperature and CO<sub>2</sub> concentration on growth and lipids in green algae and cyanobacteria 482  
Madhulika Shukla, Rizwana Tabassum, Rajendra Singh & Dolly Wattal Dhar\*

\*Author for correspondence

# Indian Journal of Open Learning

VOLUME 24

NUMBER 1&2

JANUARY AND MAY 2015

## CONTENTS

<b>Editorial</b>	1
<b>PAPERS</b>	
Perceptions of Supervisors on the Value of Distance Learning Undergraduate Research Projects in Zimbabwe <i>Manyanhaire Itai Offat, and Chitura Miriam</i>	3
Transforming Teaching and Learning through Technology: A Case Study of the Institute of Extra Mural Studies of the National University of Lesotho <i>Bothephana Makhakhane</i>	15
The Perception of B.Ed. Students on Printed Self-Learning Material and Learning Style in ODL <i>Niradhar Dey and S.V.S. Chaudhary</i>	23
Design and Development of Blended Learning Course: A Pilot Study <i>Manjari Agarwal</i>	41
OER and Teacher Education: Awareness and Barriers <i>Tulika Bansal and Dhananjay Joshi</i>	59
<b>BOOK REVIEW</b>	
<i>MOOCs and Open Education Around the World</i> Edited by Curtis J. Bonk, Mimi M. Lee, Thomas, C. Reeves and Thomas H. Reynolds <i>Yun-Jo An</i>	69
<b>WORKSHOP REPORT</b>	71
3-Day Workshop on Student Evaluation in Open and Distance Learning <i>Anita Priyadarshini</i>	
<b>HINDI ABSTRACTS OF PAPERS</b>	75
<i>Kanwaljeet Kaur and Jyoti Malik</i>	